

RoHS COMPLIANT

CUSTOMER DRAWING

REV.	ECO. NO.	DESCRIPTION	DATE
C	ES160112	Add the Plating Code.	2016.01.15
D	ES160904	Add the Key Type.	2016.09.13
E	ES170306	Add the red color type.	2017.03.29
F	ES171119	Add the Key Type.	2017.11.24
G	ES171214	Add blue&orange color Type.	2017.12.25
H	ES180119	Add the Key Type.	2018.01.22

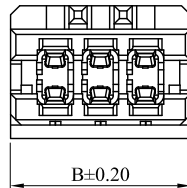
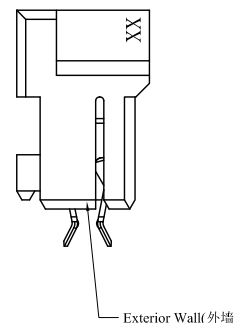
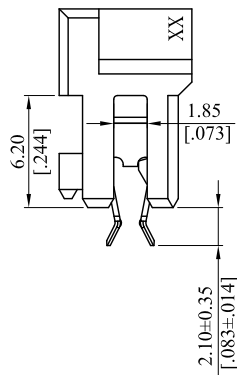
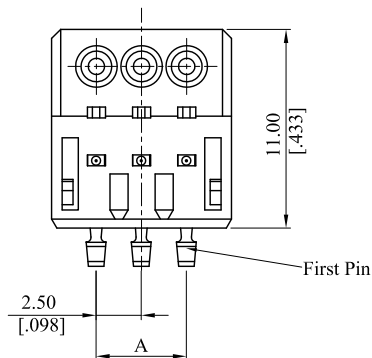
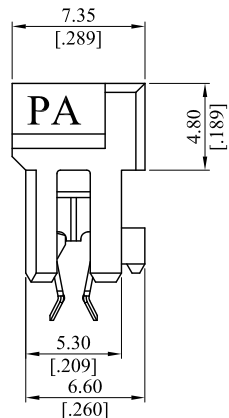

A=2.50*(No. of circuit-1)
B=A+5.0

Note:

Material:

Insulator: PA66+30%GF, UL94 V-0, Nature.

Terminal: Phosphor Bronze;

Specification:

Voltage Rating: 250V;

Temperature Rating: -40℃~+110℃;

General part number:

2514S ** D * **
I 2 3 4

1. R*:No. of circuits.(Color:Red)

B*:No. of circuits.(Color:Blue)

C*:No. of circuits.(Color:Orange)

**:.No. of circuits.(Color:Nature)

2. D: With Lock.

3. 0= Tin plated 120~200u" over Ni 30u" overall, for AWG #22~#24.

1= Tin plated 120~200u" over Ni 30u" overall, for AWG #26.

U= Gold Flash over Ni 80~150u" overall.

4. See the Table of next page.

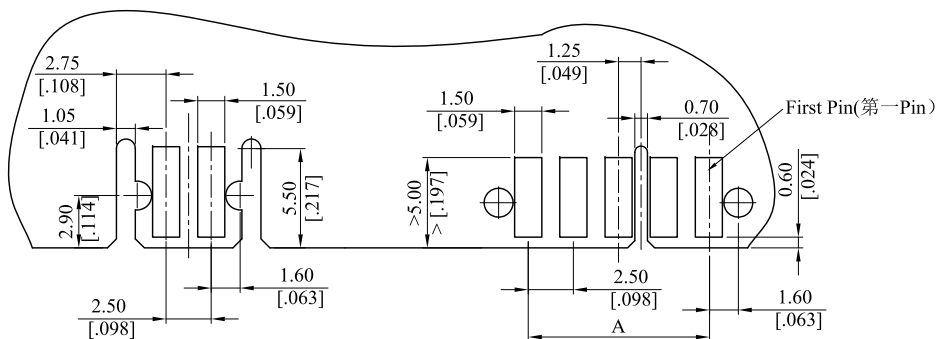
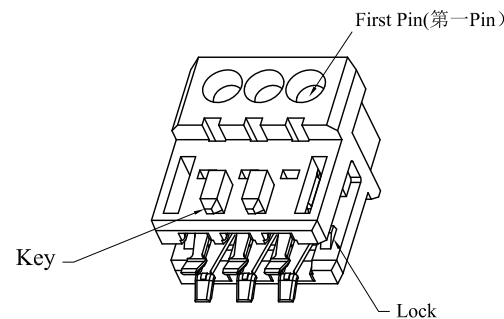

PCB LAYOUT

TOLERANCE UNLESS OTHERWISE SPECIFIED			LEOCO CORPORATION http://www.leoco.com.tw		
mm	mm	inch	APPROVED BY:	DATE:	TITLE:
[inch]			Gordon	2018.01.22	Rast 2.5 Connector
			Checked BY: Topmoon	DATE: 2018.01.22	
1 PLACE	± 0.30	± ---	DRAWN BY: shana	DATE: 2018.01.22	PART NO.: 2514S**D***
2 PLACES	± 0.20	± .012	SIZE: A3	SCALE: 1:1	DRAWING NO.: 251403S
3 PLACES	± 0.10	± .008	ANGULAR ±1°		REV.: H
4 PLACES	± ---	± .004			SHEET: 1 OF 3

RoHS COMPLIANT

CUSTOMER DRAWING

REV.	ECO. NO.	DESCRIPTION	DATE
C	ES160112	Add the Plating Code.	2016.01.15
D	ES160904	Add the Key Type.	2016.09.13
E	ES170306	Add the red color type.	2017.03.29
F	ES171119	Add the Key Type.	2017.11.24
G	ES171214	Add blue&orange color Type.	2017.12.25
H	ES180119	Add the Key Type.	2018.01.22

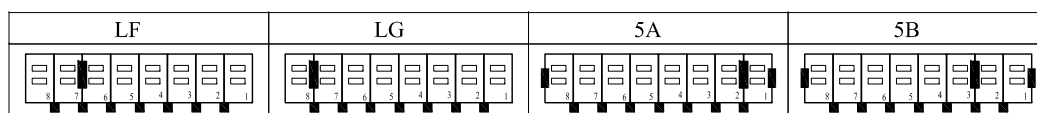
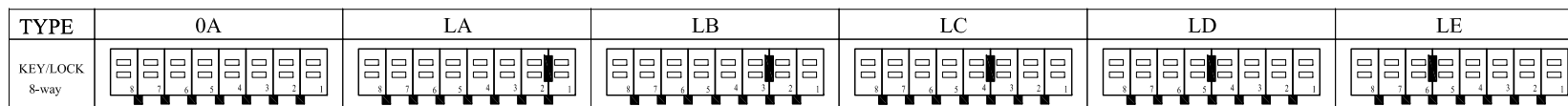
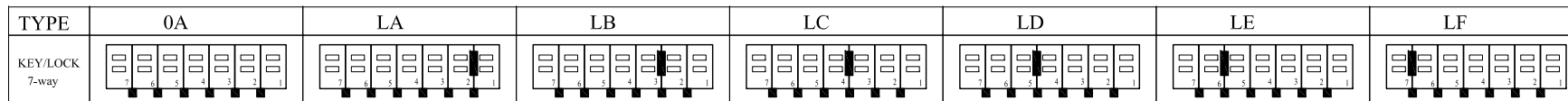
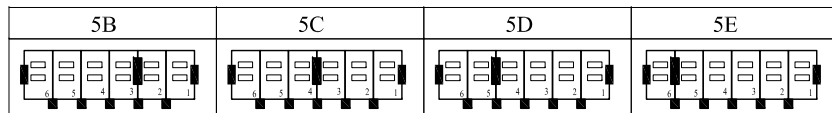
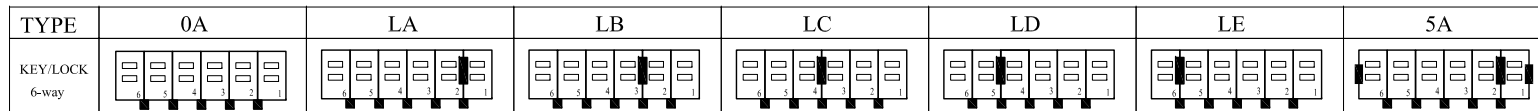
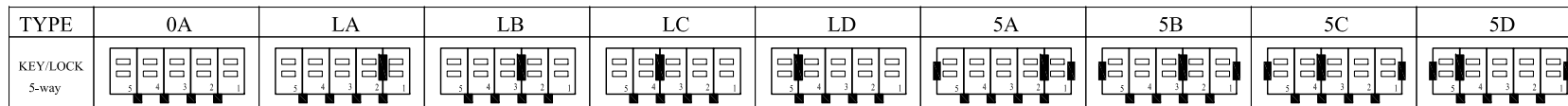
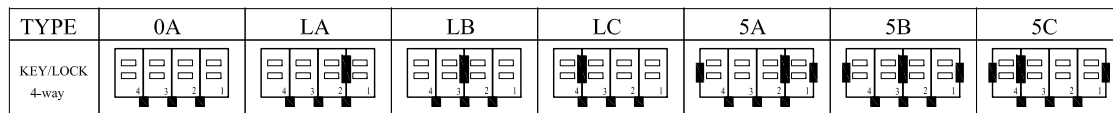
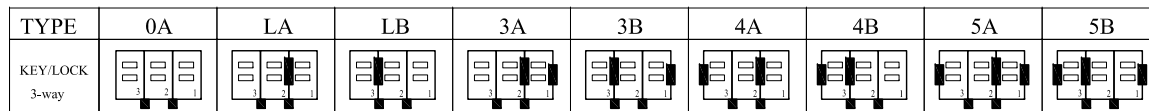
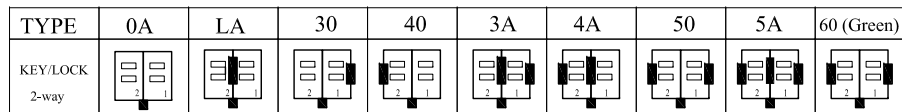

TOLERANCE UNLESS OTHERWISE SPECIFIED			LEOCO CORPORATION http://www.leoco.com.tw		
mm			APPROVED BY:	DATE:	TITLE: Rast 2.5 Connector
[inch]	mm	inch	Gordon	2018.01.22	
1 PLACES	± 0.30	± ---	CHECKED BY:	DATE:	PART NO.: 2514S**D***
2 PLACES	± 0.20	± .012	Topmoon	2018.01.22	
3 PLACES	± 0.10	± .008	DRAWN BY:	DATE:	DRAWING NO.: 251403S
4 PLACES	± ---	± .004	shana	2018.01.22	
ANGULAR ±1°			SIZE: A3	SCALE: 1:1	
			REV.: H	SHEET: 2 OF 3	

RoHS COMPLIANT

CUSTOMER DRAWING

REV.	ECO. NO.	DESCRIPTION	DATE
C	ES160112	Add the Plating Code.	2016.01.15
D	ES160904	Add the Key Type.	2016.09.13
E	ES170306	Add the red color type.	2017.03.29
F	ES171119	Add the Key Type.	2017.11.24
G	ES171214	Add blue&orange color Type.	2017.12.25
H	ES180119	Add the Key Type.	2018.01.22

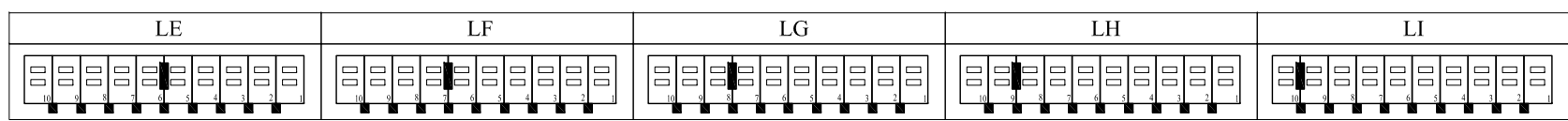
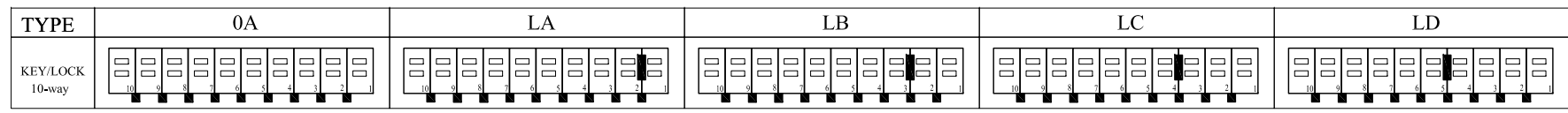
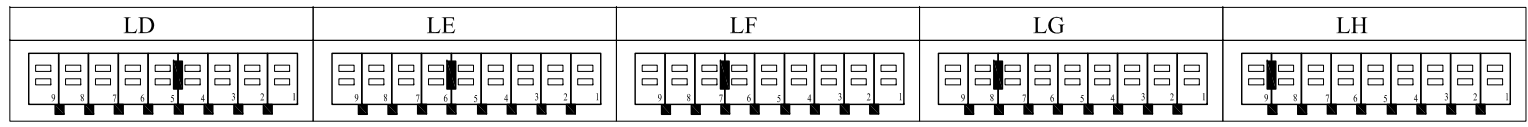
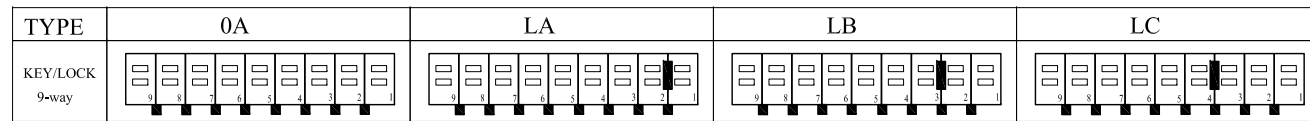

For example:

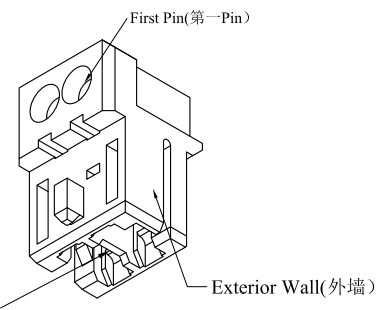
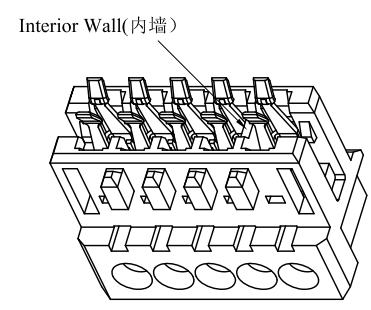
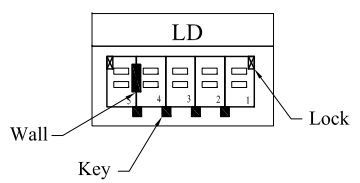

TOLERANCE UNLESS OTHERWISE SPECIFIED			LEOCO CORPORATION http://www.leoco.com.tw		
mm	[inch]		APPROVED BY:	DATE:	TITLE:
	mm	inch	Gordon	2018.01.22	
1 PLACES	± 0.30	± ---	CHECKED BY:	DATE:	Rast 2.5 Connector
2 PLACES	± 0.20	± .012	Topmoon	2018.01.22	
3 PLACES	± 0.10	± .008	DRAWN BY:	DATE:	PART NO.:
4 PLACES	± ---	± .004	shana	2018.01.22	
ANGULAR ±1°			SIZE:	SCALE:	DRAWING NO.:
			A3	1:1	
					REV.:
					H
					SHEET:
					3 OF 3