

*** 5001 Series ***

Material :

* Insulstor : UL 94V-0 NYLON 6/6

 :the slot only for 2 circuits

* Contact : Brass

* Plating : Tin plated 120μ " min over 30μ " min. nickel overall

RoHS COMPLIANT

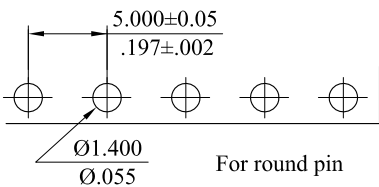
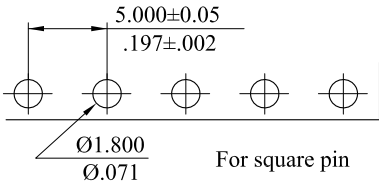
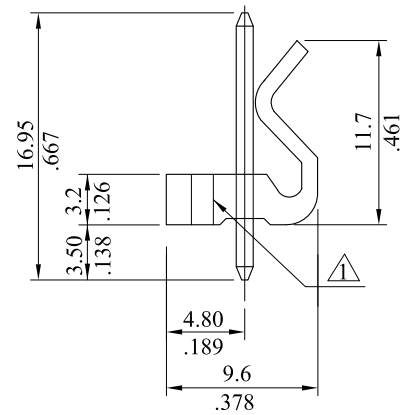
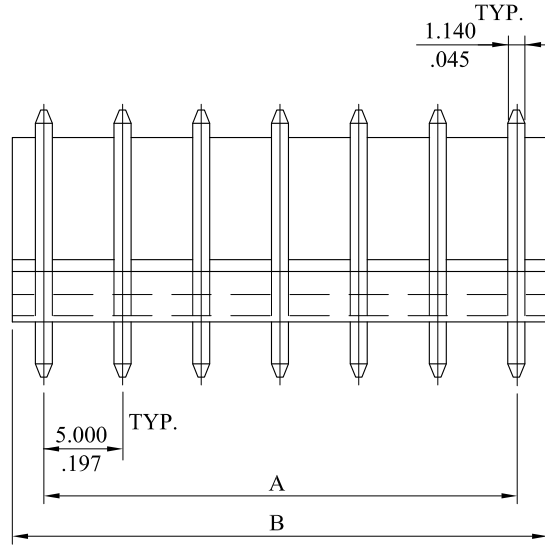
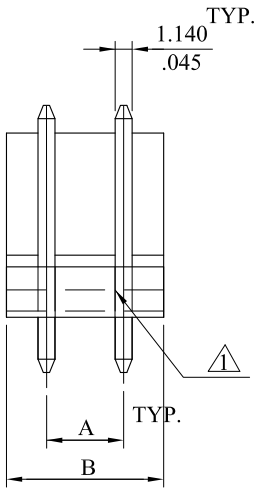
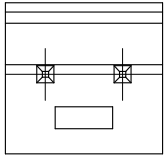

Recommended Hole Pattern

Circuits	Part No.		Dimension	
	Square Pin	Round Pin	A	B
2	5001P020013	5001P020R13	5.00(.197)	10.0(.394)
3	5001P030013	5001P030R13	10.00(.394)	15.0(.591)
4	5001P040013	5001P040R13	15.00(.591)	20.0(.787)
5	5001P050013	5001P050R13	20.00(.787)	25.0(.984)
6	5001P060013	5001P060R13	25.00(.984)	30.0(1.181)
7	5001P070013	5001P070R13	30.00(1.181)	35.0(1.378)
8	5001P080013	5001P080R13	35.00(1.378)	40.0(1.575)
9	5001P090013	5001P090R13	40.00(1.575)	45.0(1.772)
10	5001P100013	5001P100R13	45.00(1.772)	50.0(1.969)
11	5001P110013	5001P110R13	50.00(1.969)	55.0(2.165)
12	5001P120013	5001P120R13	55.0(2.165)	60.0(2.362)
13	5001P130013	5001P130R13	60.0(2.362)	65.0(2.559)
14	5001P140013	5001P140R13	65.0(2.559)	70.0(2.756)
15	5001P150013	5001P150R13	70.0(2.756)	75.0(2.953)
16	5001P160013	5001P160R13	75.0(2.953)	80.0(3.150)

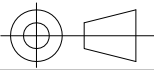
				 LECO CORPORATION	APPROVED:		PART NO.:					
D	ES101218				DATE:		5001P**0*13					
C	ES020903			GENERAL TOLERANCES: (UNLESS SPECIFIED)		CHECKED:		TITLE:				
B	ES020431				mm	inch	DATE:		HEADER			
A	DWG REL			1 PLACE	± 0.30	± --	DRAWN:		DRAWING NO.:			
REV.	ECO. NO.	CHG.	APP.	2 PLACES	± 0.20	± .012	DATE:		500101S			
				3 PLACES	± 0.10	± .008		UNITS	SCALE	SIZE	SHEET	REV.
				4 PLACES	± --	± .004		mm inch	2:1	A4	1/1	D
				ANGULAR ± (1°)								